



Instituut voor Landbouw- en Visserijonderzoek

## Lessons from SMEthane:

# Developing in vivo screens to measure the effect of plant extracts on methane production

Sam De Campeneere, Nico Peiren, Diego Morgavi,  
Kenton Hart

March 2012

Institute for Agricultural and Fisheries Research

Animal Science

[www.ilvo.vlaanderen.be](http://www.ilvo.vlaanderen.be)

# Overview of the most common used in vivo measurements (within SMEthane)

- Respiration chamber
- **Open circuit chamber (ILVO, Aberystwyth)**
- Hood-type gas exchange chamber
- Tunnel
- Micrometeorological mass balans
  
- **SF6 tracer technique (INRA)**
- Intragastric infusion
  
- Milk fatty acids analysis

# SMEthane

Planned long term trials: 21

Today: partial results from

- INRA: 2 trials
- ILVO: 2 trials

w1	w2	w3	w4	w5	w6	w7	w8
cont	Contr <b>X</b>	Test	Test <b>X</b>	Test	Test <b>X</b>	Test	Test <b>X</b>

# INRA

Tracer: 10 (out of 100) units/t recovered  
CH<sub>4</sub>: 5 units/t recovered



# SF<sub>6</sub>

- SF<sub>6</sub> tracer in rumen bolus
- Vacuümcanule
- Halster with sampling device



# Methane production, intake and milk production of cows supplemented with product X

	Before		During treatment				SEM		
			2 weeks		4 weeks			6 weeks	
<b>Methane</b>									
<b>g/cow/d</b>	293.3	a	286.0	a	248.6	a	201.3	b	17.88
<b>g/kg DMI</b>	12.8	a	12.2	ab	10.5	ab	9.9	b	1.48
<b>g/kg milk</b>	18.0	a	17.1	a	15.1	ab	13.1	b	1.12
<b>Dry matter intake, kg/d</b>	16.3	b	16.8	ac	16.5	bc	15.3	d	0.23
<b>Milk production, kg/d</b>	23.8	ab	24.4	a	24.9	a	21.5	b	1.85

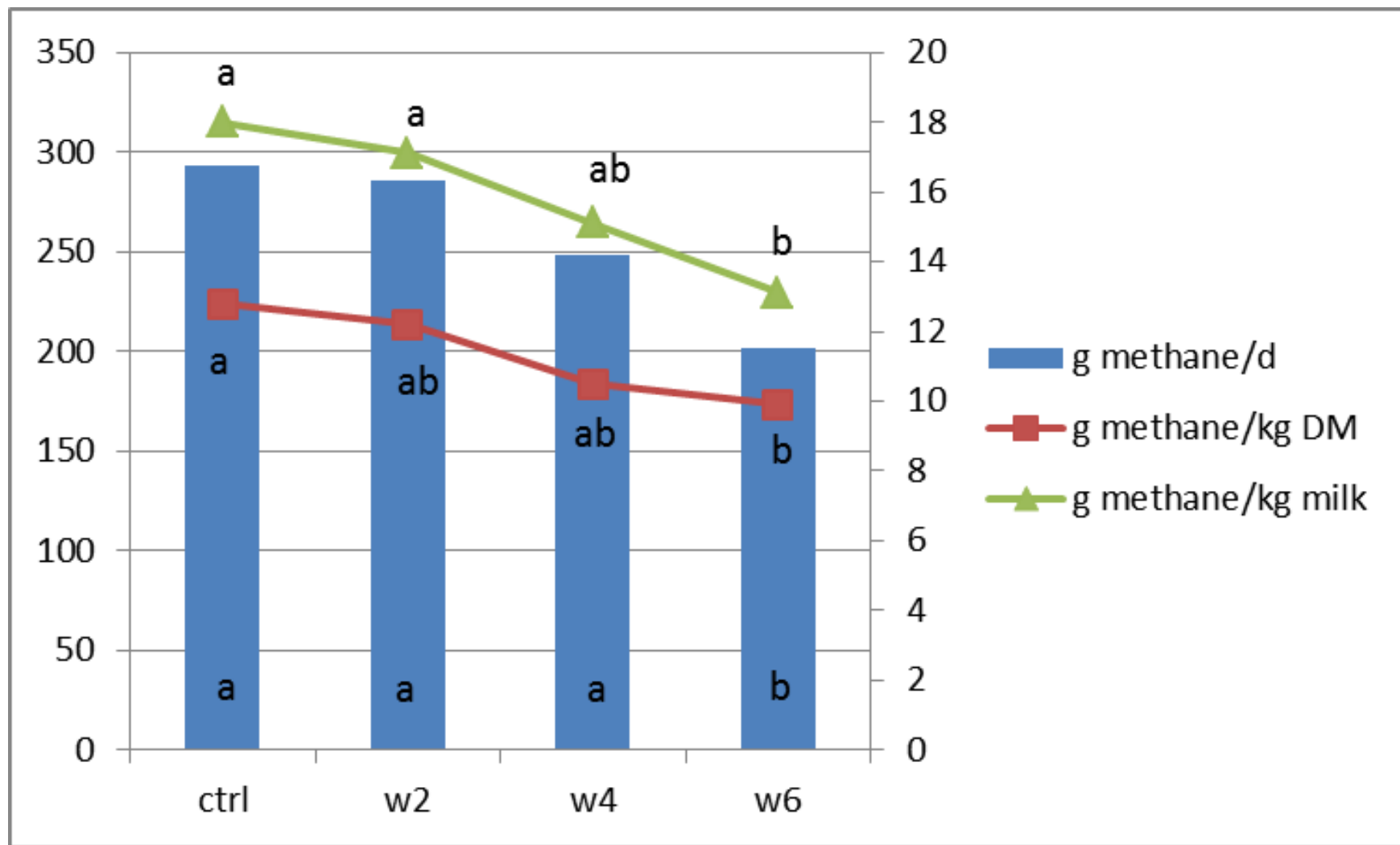

# Methane production and milk production of cows supplemented with product y

	Before	During treatment						SEM
		2 weeks	4 weeks	6 weeks				
<b>Methane</b>								
<b>g/cow/d</b>	357.3	341.6	300.9	297.3			39.88	
<b>g/kg milk</b>	21.2 ab	20.7 ab	19.0 b	24.1 a			2.09	
<b>Milk production, kg/d</b>	17.2 a	16.3 ab	15.6 b	12.6 c			1.31	



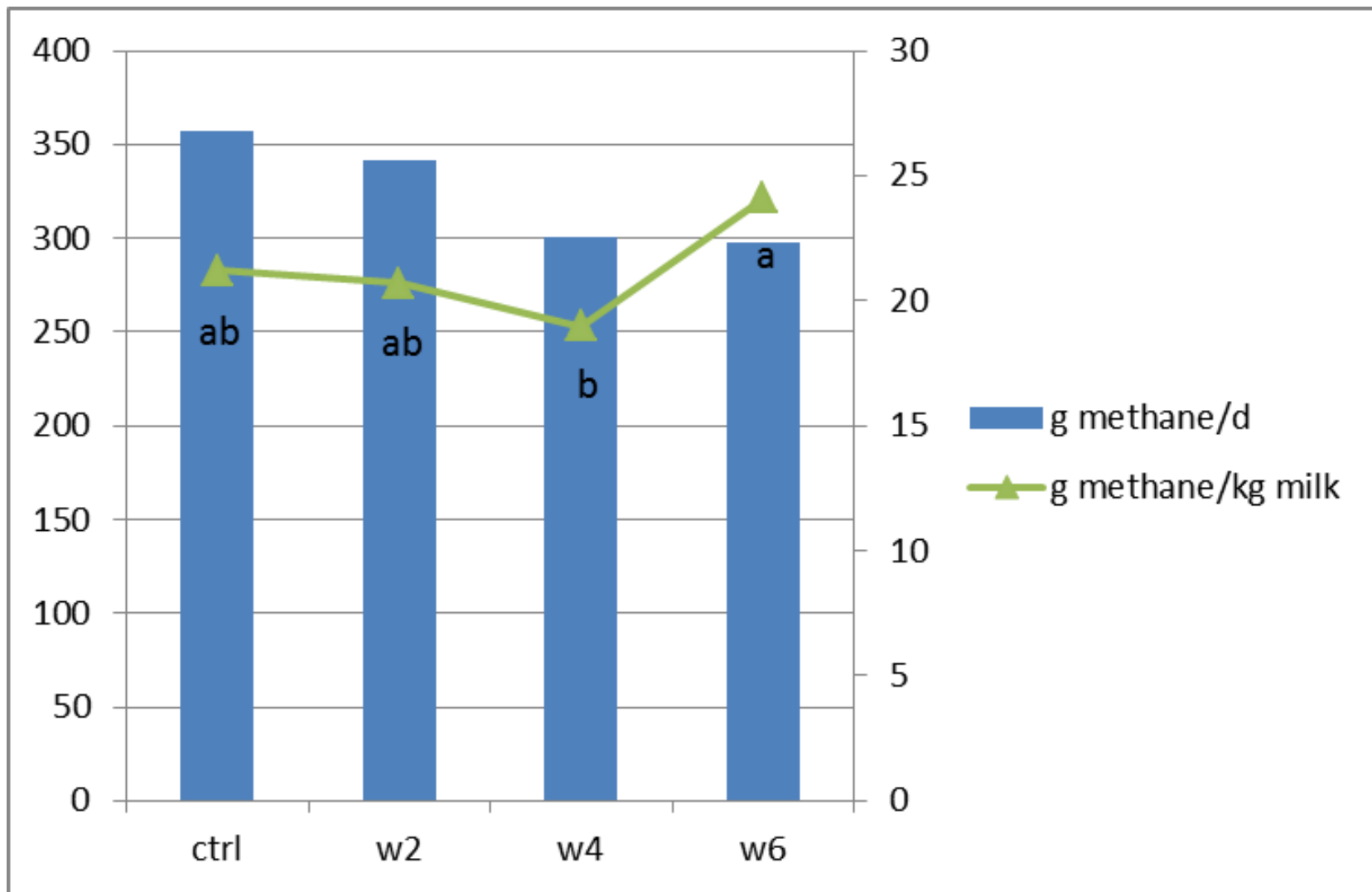

# ILVO

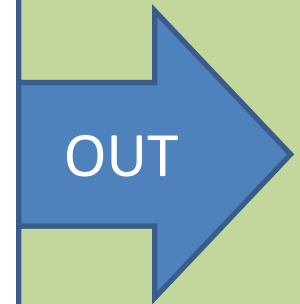
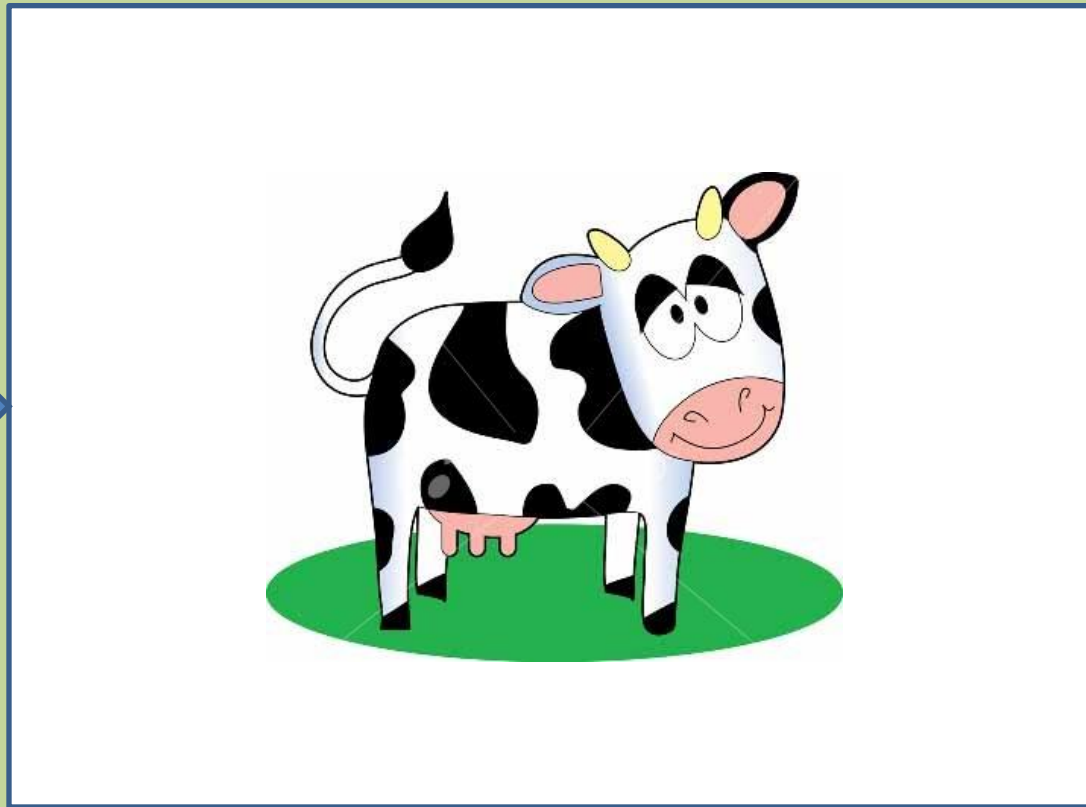
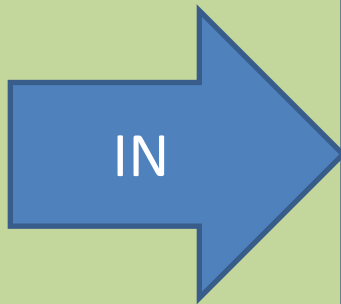

# Open circuit gas exchange rooms

- Sealed chambre with ventilators
- Online measurement of CH<sub>4</sub> and possibly other gasses
- No calorimetric
- Underpressure

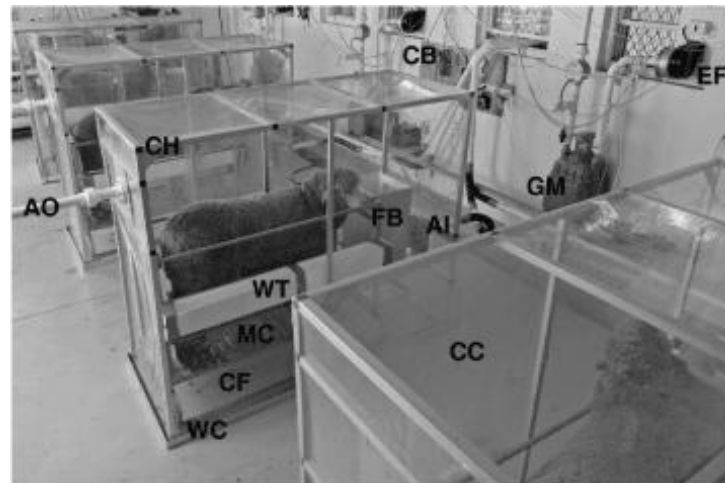

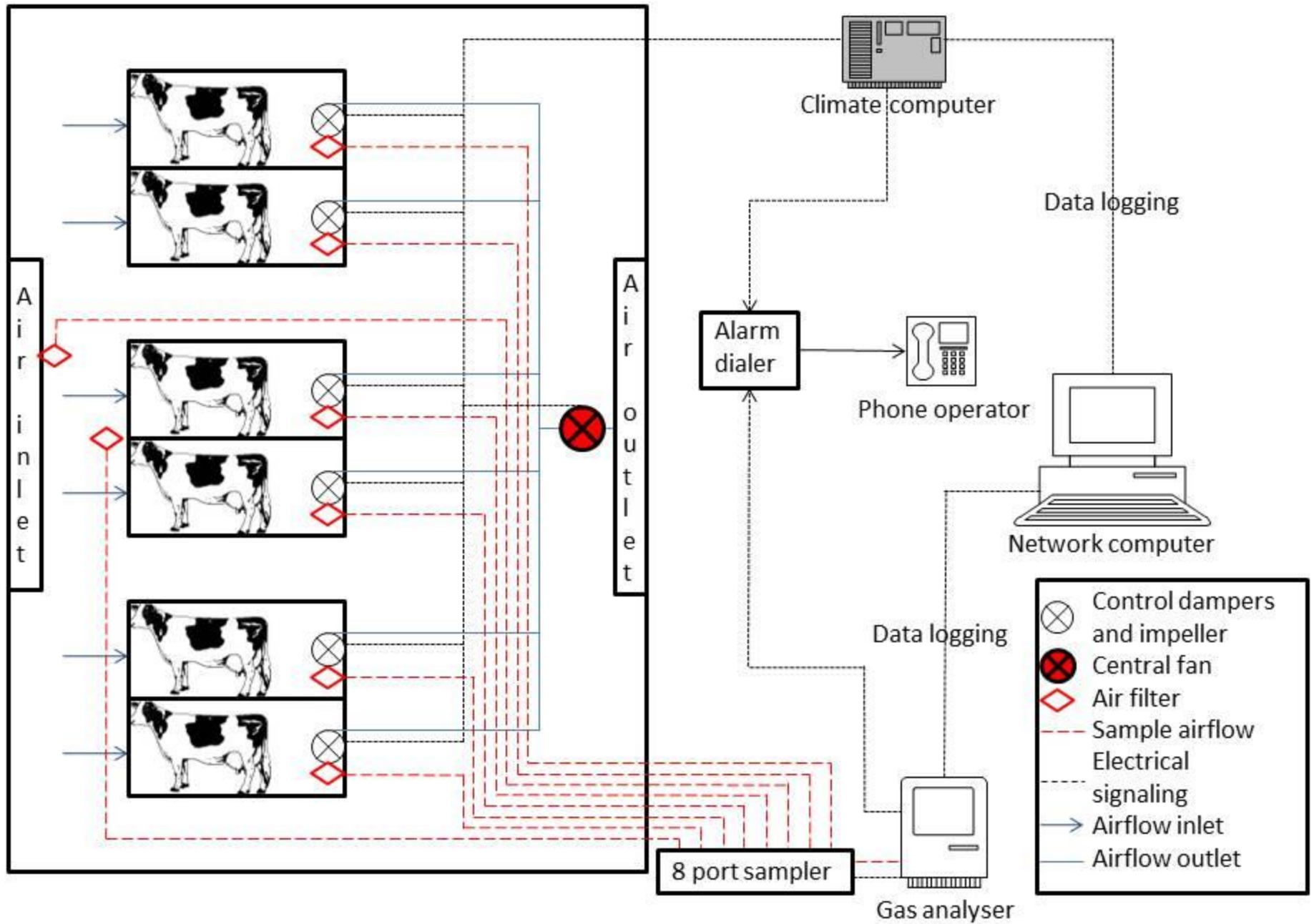

# Methane measurement chambers at ILVO

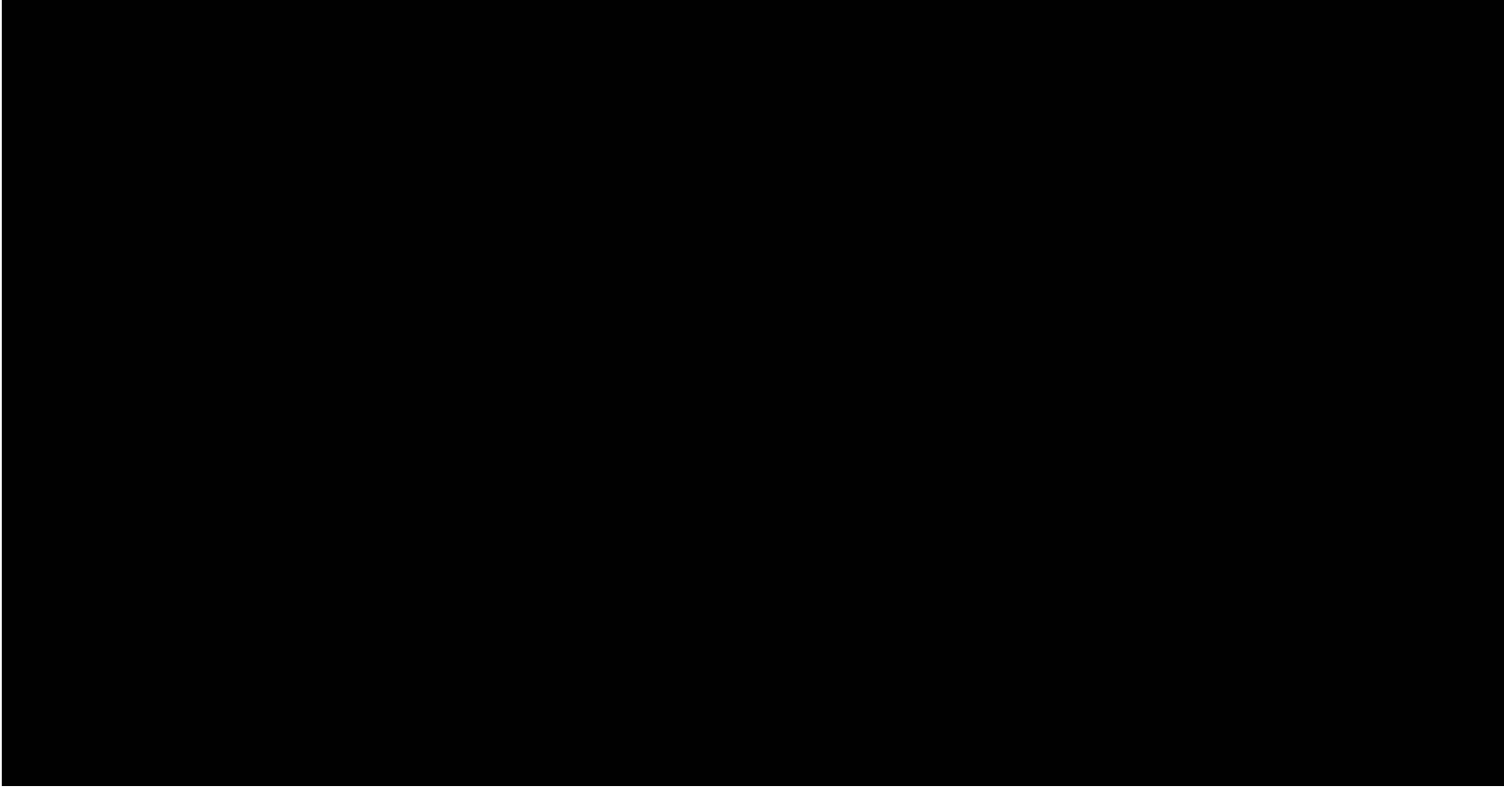

# Methane production of cows supplemented with product a en b

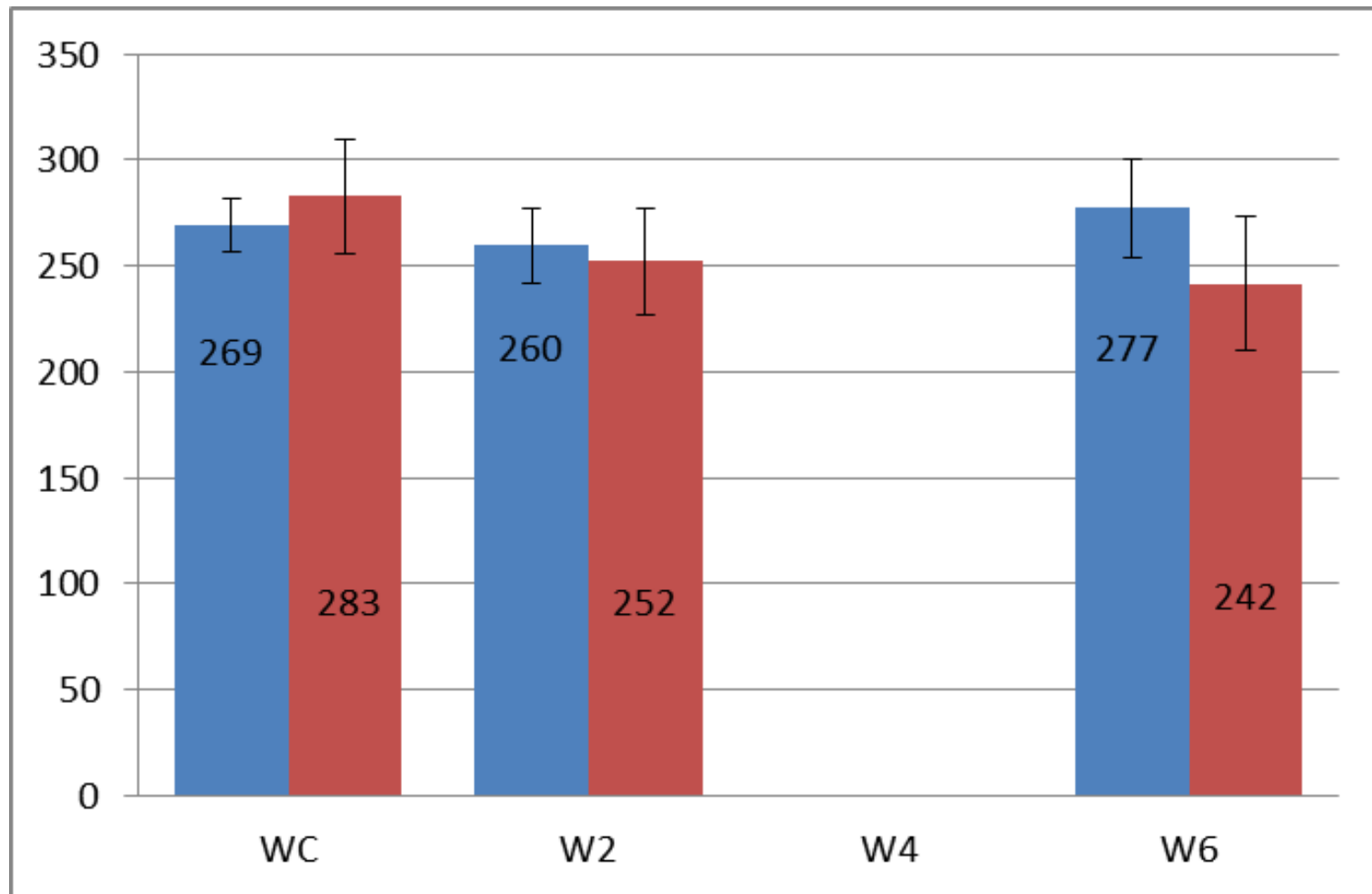



Instituut voor Landbouw- en Visserijonderzoek

# Thank you for your attention

Workshop SMEthane  
September 2011

Institute for Agricultural and Fisheries Research

Animal Science  
[www.ilvo.vlaanderen.be](http://www.ilvo.vlaanderen.be)

